

Concave Electrode Type

Model No. *1	NCR104 (NCR108)	NCR162	NCR164
Size Code Inch	0402 × 4(0804)	0603 × 2(0606)	0603 × 4(1206)
Size Code mm	1005 × 4(2010)	1608 × 2(1616)	1608 × 4(3216)

*1 (): Conventional Model No.

Construction

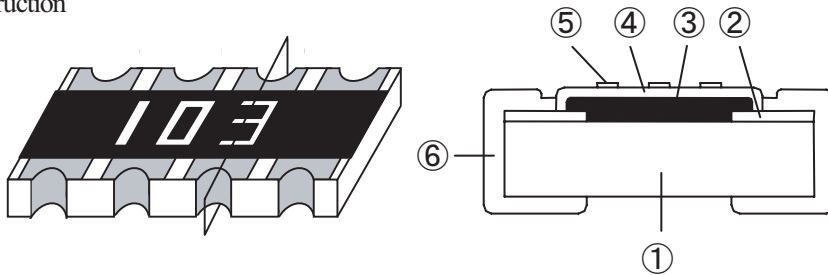

Symbol	Material List
①	Alumina substrate
②	Conductor
③	Resistive film
④	Over coat
⑤	Marking
⑥	Side termination

Model No.

NCR164		102		J		V	
① Model No.		② Resistance		③ Tolerance		④ Packaging	
① Model No. #1	② Resistance	③ Tolerance (%)	④ Packaging				
NCR104 (NCR108)	3 digit (Resistance) (Marking)	Symbol	Package				
NCR162	0 Ω → 000	J	B				
NCR164	1k Ω → 102	0 Ω type is no marking	V				

Dimension

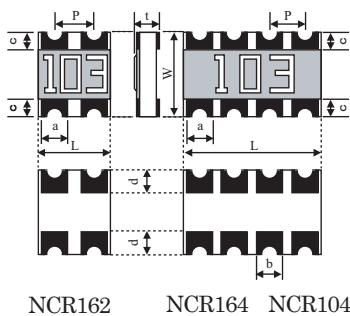

Model No.	L	W	a	b
NCR104	2.00±0.10	1.00±0.10	0.28±0.10	(0.28)*2
NCR162	1.60±0.15	1.60±0.15	0.50±0.15	(0.50)*2
NCR164	3.20±0.15			

Model No.	c	d	p	t
NCR104	0.20±0.10	0.28±0.10	(0.50)*2	0.35±0.10
NCR162	0.35±0.15	0.40±0.15	(0.80)*2	0.45±0.10
NCR164				

*2 (): Reference value

Rating

*1 Model No.	Rated Wattage (70°C)	Tolerance (%)	Resistance Range E-24 Series (Ω)	T.C.R. (ppm/°C)	Max. Working Voltage (V)	Max. Overload Voltage (V)	Circuit	0 Ω Type	
								Rated Current	Resistance
NCR104 (NCR108)	0.031W/Element	J: ± 5	10 ~ 1M	±200	50	100		1A/Element	Max. 50m Ω
NCR162	0.063W/Element								
NCR164									

Operating temperature range : -55 °C ~ +155 °C
Please contact our sales offices about custom use circuits.

Power rating, Packaging

Refer "Dimension, Packaging, etc."

Convex Electrode Type

Model No. *1	ACR102 (CRA104)	ACR104 (CRA108)	ACR164 (CRA168)
Size Code Inch	0402 × 2(0404)	0402 × 4(0804)	0603 × 4(1206)
Size Code mm	1005 × 2(1010)	1005 × 4(2010)	1608 × 4(3216)

*1 (): Conventional Model No.

Construction

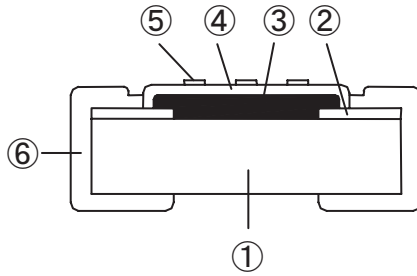
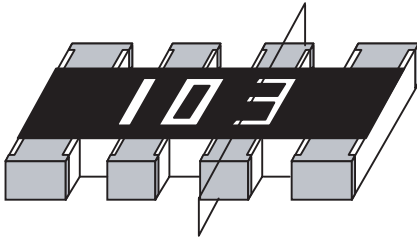

Symbol	Material List
①	Alumina substrate
②	Conductor
③	Resistive film
④	Over coat
⑤	Marking *2
⑥	Side termination

*2 ACR102 and ACR104: No marking

Model Designation

ACR164 (CRA168)

102

J

V

① Model No.

② Resistance

③ Tolerance

④ Packaging

① Model No. *1
ACR102 (CRA104)
ACR104 (CRA108)
ACR164 (CRA168)

② Resistance
3 digit
(Resistance) (Marking)
0 Ω → 000
1k Ω → 102

③ Tolerance(%)	
Symbol	Tolerance
J	±5
0 Ω type is no marking	

④ Packaging	
Symbol	Packaging
B	Bulk
V	Paper Taping

Dimension

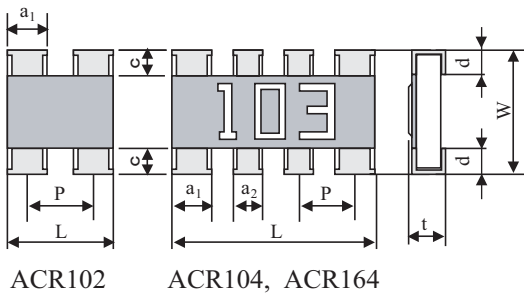

Model No.	L	W	a1	a2
ACR102	1.00±0.20	1.00±0.20	0.33±0.05	-
ACR104	2.00±0.20	1.00±0.20	0.40±0.15	0.30±0.15
ACR164	3.20±0.10	1.60±0.10	0.60±0.15	0.40±0.15

Model No.	c	d	p	t
ACR102	0.15±0.15	0.25±0.10	(0.65)*3	0.35±0.05
ACR104	0.20±0.15	0.20±0.15	(0.50)*3	0.35±0.10
ACR164	0.30±0.20	0.25±0.15	(0.80)*3	0.50±0.10

*3 (): Reference value

Rating

Model No.	Rated Wattage (70°C)	Tolerance (%)	Resistance Range E-24 Series (Ω)	T.C.R. (ppm/°C)	Max. Working Voltage (V)	Max. Overload Voltage (V)	Circuit	0 Ω Type	
								Rated Current	Resistance
ACR102 (CRA104)	0.063W/Element	J	10 ~ 1M	±200	50	100		1A/Element	Max. 50m Ω
ACR104 (CRA108)	0.031W/Element								
ACR164 (CRA168)	0.063W/Element								

Operating temperature range : -55 °C ~ +155 °C

Power rating, Packaging

Refer "Dimension, Packaging, etc."

Concave Electrode Type : Model No. NCR3A8 (NCR3110A), NCR3B8 (NCR3110B)

Construction

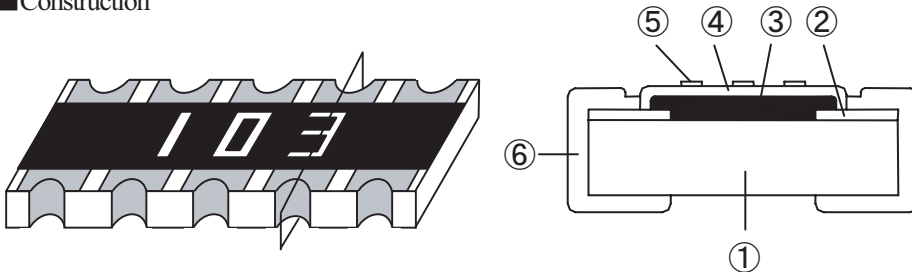

*1 (): Conventional Model No.

Symbol	Material List	
①	Alumina substrate	
②	Conductor	
③	Resistive film	
④	Over coat	
⑤	Marking	NCR3A8 Orange
		NCR3B8 White
⑥	Side termination	

Model Designation

*1

NCR3A8 (NCR3110A) 103 J E
 ① Model No. ② Resistance ③ Tolerance ④ Packaging

① Model No.*1
NCR3A8 (NCR3110A)
NCR3B8 (NCR3110B)

② Resistance
3 digit (Resistance) (Marking) 10kΩ → 103

③ Tolerance(%)	
Symbol	Tolerance
J	± 5

④ Packaging	
Symbol	Packaging
B	Bulk
E	Embossed taping

Dimension

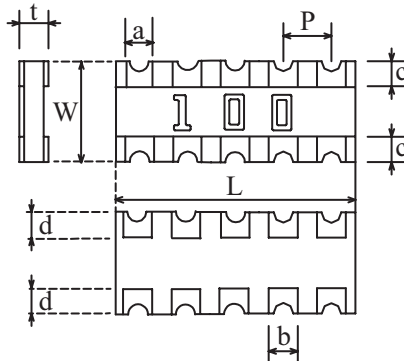

Model No.	L	W	a	b
NCR3A8	6.40±0.20	3.10±0.20	0.60±0.15	0.50±0.20
NCR3B8				

Model No.	c	d	p	t
NCR3A8	0.50±0.30	0.50±0.30	(1.27)*2	0.55±0.10
NCR3B8				

*2 (): Reference value

Rating

*1 Model No.	Rated Wattage (70°C)	Tolerance (%)	Resistance Range E-12 Series (Ω)	T.C.R. (ppm/°C)	Max. Working Voltage (V)	Max. Overload Voltage (V)	Circuit
NCR3A8 (NCR3110A)	0.063W/Element	J:± 5	100 ~ 470k	±250	50	100	
NCR3B8 (NCR3110B)							

Operating temperature range : -55°C ~ +155°C

Power rating, Packaging

Refer "Dimension, Packaging, etc."