

BM Series

◆ MAJOR USES

- Output choke coils for Switching Mode Power Supply
- Choke coils for DC-DC converter
- Normal mode choke coils for noise control

◆ FEATURES

- Miniaturization in comparison with TM series coils
- High inductance in low load current
- Low leakage flux due to gap-less structure



◆ CORE STANDARD SPECIFICATIONS

Core Part No. (Old Core Part No.)	Abbreviation	Cross Sectional Area cm ²	Magnetic Path Length cm	Outside Dimensions			Inductance Coefficient AL Value		
				Outer Diameter mm	Width mm	Height mm	Idc=0[A] μH	Rated Current* μH	Rated Current Ampere Turn [AT]
LPB150905N (B150905N)	X2	0.140	3.85	17.2	7.3	6.4	0.079	0.047	100
LPB190910N (B190910N)	XU	0.447	4.49	21.6	7.3	11.9	0.248	0.100	200
LPB221310N (B221310N)	X6	0.396	5.50	24.7	10.5	12.0	0.153	0.065	240
LPB251510N (B251510N)	X7	0.430	6.28	28.3	12.7	12.3	0.153	0.068	270
LPB251515N (B251515N)	X8	0.645	6.28	28.3	12.7	17.5	0.226	0.091	300
LPB322015N (B322015N)	XR	0.774	8.17	35.2	17.5	17.3	0.229	0.091	350
LPB372315N (B372315N)	XJ	0.924	9.42	40.5	19.5	18.0	0.209	0.096	375
LPB462715N (B462715N)	XQ	1.254	11.50	49.4	22.7	18.0	0.232	0.084	600
LPB462720N (B462720N)	XC	1.634	11.50	49.4	22.7	23.0	0.310	0.112	600

*200[kHz], ±25%

◆ CORE LOSS CHARACTERISTICS

- BM choke

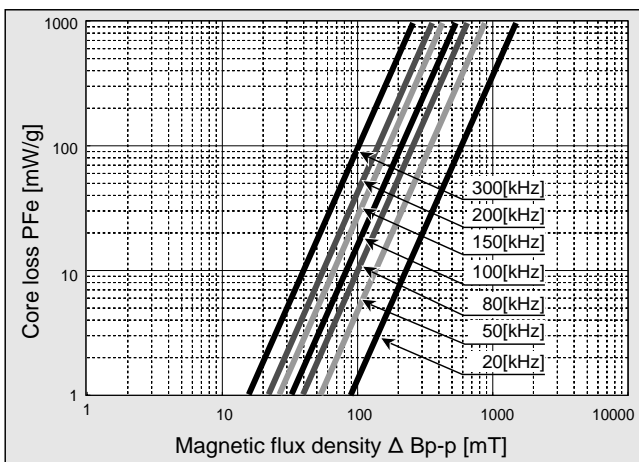

◆FREQUENCY - INDUCTANCE CHARACTERISTICS

●BM choke

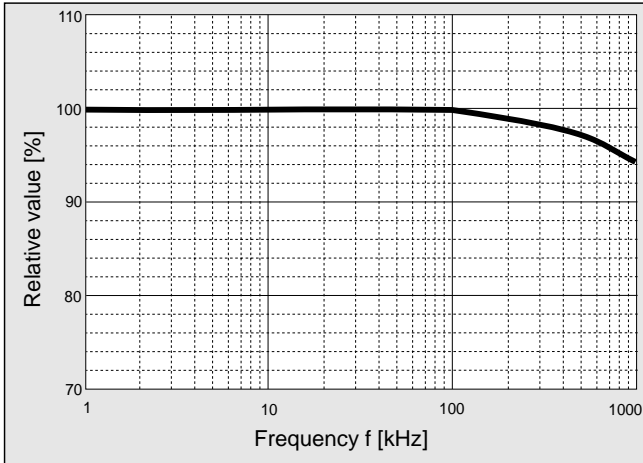

◆TEMPERATURE DEPENDENCE
- INDUCTANCE AND CORE LOSS

●Frequency : 200[kHz]

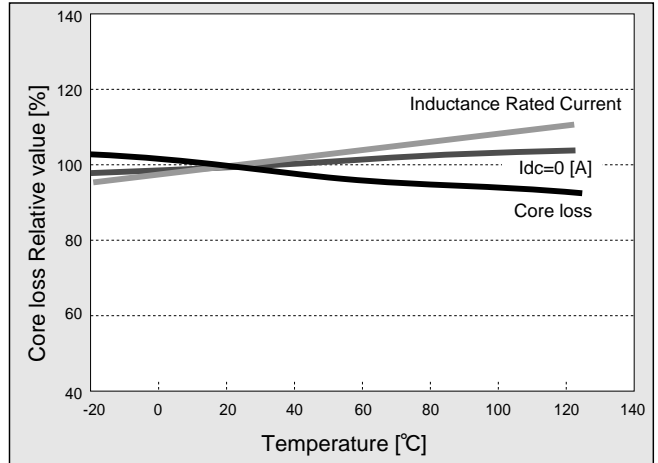

◆B-H CURVE

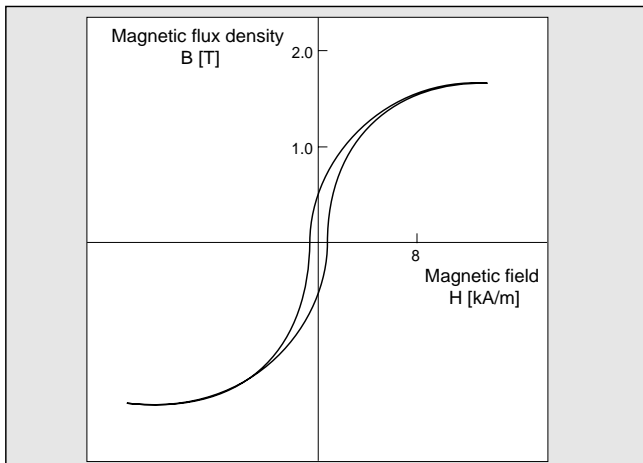

◆D.C. BIAS CHARACTERISTICS AL-AT(1)

●Frequency : 200[kHz]

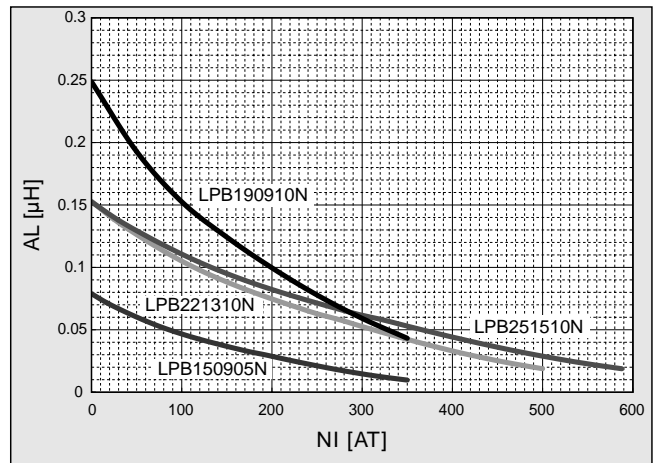

◆D.C. BIAS CHARACTERISTICS AL-AT(2)

●Frequency : 200[kHz]

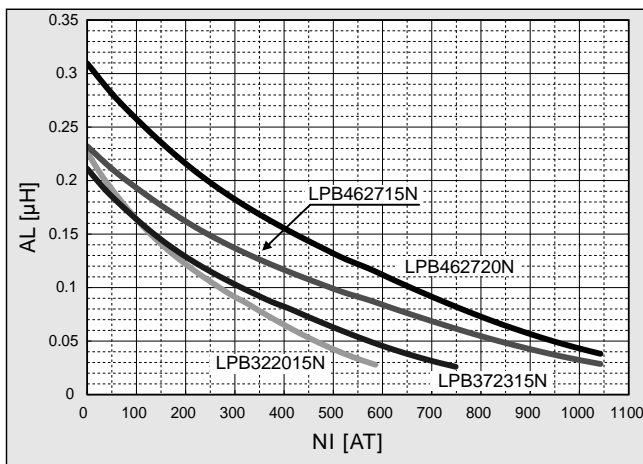

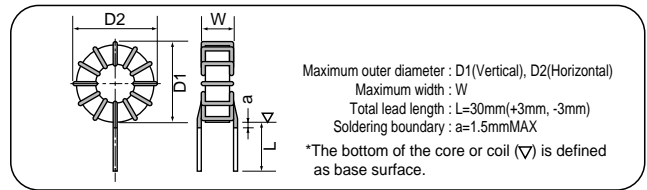

◆ COIL STANDARD SPECIFICATIONS

Coil Part No. (Old Coil Part No.)	Rated Current A	Inductance (200kHz) ^{*1}		D.C.R. mΩ (max)	Winding ^{*2} mmφ×lines-turns	Outside Dimensions		
		0[A] μH	Rating μH			D1 mm	D2 mm	W mm
◎ LBBM003421X6-V00 (BM03421X6)	3	1100	420	130	0.8×1p - 80T	29.0	29.0	17.5
◎ LBBM005161X6-V00 (BM05161X6)	5	360	160	55	1.0×1p - 48T	29.0	29.0	18.0
◎ LBBM008600X6-V00 (BM08600X6)	8	140	60	20	0.9×2p - 30T	29.0	29.0	18.0
◎ LBBM010300X6-V00 (BM10300X6)	10	62	30	11	1.0×2p - 20T	29.0	29.0	18.0
◎ LBBM015150X6-V00 (BM15150X6)	15	35	15	6	1.0×3p - 15T	29.5	29.5	18.5
◎ LBBM020100X6-V00 (BM20100X6)	20	23	10	4	1.0×4p - 12T	29.5	29.5	18.5
◎ LBBM025060X6-V00 (BM25060X6)	25	13	6	2	1.2×4p - 9T	30.0	30.0	19.0
◎ LBBM0303R6X6-V00 (BM30040X6)	30	7.6	3.6	2	1.3×4p - 7T	31.0	31.0	19.5
◎ LBBM003551X7-V00 (BM03551X7)	3	1400	550	150	0.8×1p - 90T	32.5	32.5	18.0
◎ LBBM005201X7-V00 (BM05201X7)	5	460	200	60	1.0×1p - 54T	32.0	32.5	18.0
◎ LBBM008800X7-V00 (BM08800X7)	8	180	80	23	0.9×2p - 34T	32.5	33.0	18.5
◎ LBBM010500X7-V00 (BM10500X7)	10	110	50	16	1.0×2p - 27T	32.5	33.0	18.5
◎ LBBM015270X7-V00 (BM15270X7)	15	62	27	8	1.0×3p - 20T	33.0	33.5	19.0
◎ LBBM020150X7-V00 (BM20150X7)	20	35	15	5	1.2×3p - 15T	33.5	33.5	20.0
◎ LBBM025090X7-V00 (BM25090X7)	25	22	9	3	1.2×4p - 12T	33.5	33.5	21.0
◎ LBBM030070X7-V00 (BM30070X7)	30	16	7	3	1.3×4p - 10T	34.5	34.5	21.0
◎ LBBM035050X7-V00 (BM35050X7)	35	12	5.0	3	1.4×4p - 9T	34.0	34.0	21.0
◎ LBBM0403R4X7-V00 (BM40030X7)	40	7.6	3.4	2	1.4×5p - 7T	35.0	35.0	21.0

*1 Rated inductance tolerance : ±25%, the inductance at current 0[A] indicates the reference value.

*2 The number of turns indicates the reference value.

The specification of the inductance takes precedence over that of the number of turns.

There is a horizontal putting type in all items in the above list. "V" changes into "H" in last the third digit of the name of items.

There is a type with the length putting seat in ● item in the above list. "V" changes into "D" in last the third digit of the name of items.

There are the type with the length putting seat and the horizontal putting seat in ◎ item.

The type with the length putting seat is "V" changes into "B" in last the third digit of the name of items.

*Order the auxiliary pins separately if they are required for the pedestal.

Please select them according to the situation.

◆COIL STANDARD SPECIFICATIONS

Coil Part No. (Old Coil Part No.)	Rated Current A	Inductance (200kHz) ¹⁾		D.C.R. mΩ (max)	Winding ²⁾ mmφ×lines-turns	Outside Dimensions		
		0[A] μH	Rating μH			D1 mm	D2 mm	W mm
○ LBBM003801X8-V00 (BM03801X8)	3	1800	800	185	0.8×1P - 88T	33.0	33.0	24.5
○ LBBM005351X8-V00 (BM05351X8)	5	840	350	85	1.0×1p - 60T	34.0	34.0	24.5
○ LBBM008121X8-V00 (BM08121X8)	8	280	120	30	1.3×1p - 35T	34.0	34.0	24.5
○ LBBM010750X8-V00 (BM10750X8)	10	170	75	17	1.1×2p - 27T	34.0	34.0	25.5
○ LBBM015350X8-V00 (BM15350X8)	15	84	35	9	1.3×2p - 19T	34.5	34.5	25.0
○ LBBM020210X8-V00 (BM20210X8)	20	52	21	6	1.2×3p - 15T	34.0	34.0	26.0
○ LBBM025130X8-V00 (BM25130X8)	25	33	13	4	1.2×4p - 12T	35.0	35.0	26.0
○ LBBM030090X8-V00 (BM30090X8)	30	23	9	3	1.3×4p - 10T	35.5	35.5	27.0
○ LBBM0357R5X8-V00 (BM35070X8)	35	20	7.5	3	1.4×4p - 9T	35.0	35.0	27.5
○ LBBM040050X8-V00 (BM40050X8)	40	12	5.0	2	1.4×5p - 7T	36.5	36.5	26.5
○ LBBM003122XR-V00 (BM03122XR)	3	2800	1200	155	1.0×1p -100T	41.5	41.5	26.5
○ LBBM005481XR-V00 (BM05481XR)	5	1100	480	100	1.1×1p - 70T	41.0	41.0	25.5
○ LBBM008191XR-V00 (BM08191XR)	8	460	190	40	1.3×1p - 45T	41.5	41.5	25.5
○ LBBM010121XR-V00 (BM10121XR)	10	280	120	22	1.1×2p - 35T	40.5	40.5	26.0
○ LBBM015570XR-V00 (BM15570XR)	15	140	57	13	1.3×2p - 25T	41.5	41.5	26.0
○ LBBM020310XR-V00 (BM20310XR)	20	74	31	7	1.2×3p - 18T	42.0	42.0	26.0
● LBBM025200XR-V00 (BM25200XR)	25	51	20	5	1.2×4p - 15T	41.5	41.5	26.0
● LBBM030140XR-V00 (BM30140XR)	30	33	14	4	1.3×4p - 12T	42.0	42.0	27.0
● LBBM0359R5XR-V00 (BM35100XR)	35	23	9.5	3	1.4×4p - 10T	42.0	42.0	26.0
● LBBM0406R5XR-V00 (BM40070XR)	40	15	6.5	2	1.4×5p - 8T	42.5	42.5	26.5
● LBBM0454R9XR-V00 (BM45050XR)	45	11	4.9	2	1.3×6p - 7T	42.5	42.5	26.5